

Doeskin 17th century Sporrán

Assembly of the sporrán

- 1 Sew two bottom pieces together with rough sides inward.
- 2 Punch hole in front side as shown on pattern
- 3 Fold top of leather on front and back piece over as shown on the pattern and sew smooth side out.
- 4 Fold and sew edges of belt loop as shown on pattern
- 5 Sew loop, flap & back together
(make sure seam at back does not close loop of back)
- 6 Sew bottom to back. Make sure seam is at bottom of the curve.
- 7 Turn sporrán inside out & sew bottom & front together to make a purse, then turn right side out. There should be nothing but smooth leather on outside.
- 8 Get a wide $\frac{1}{4}$ " leather thong 4' to 5' long and loop it through the top. Sew ends to the belt loop inside.
- 9 Sew two buttons, as shown on plate 26 onto sporrán as shown. (Do not block top so thong can't move).
- 10 Place two turk's heads as shown on plate 47
- 11 Slit top for buttons.

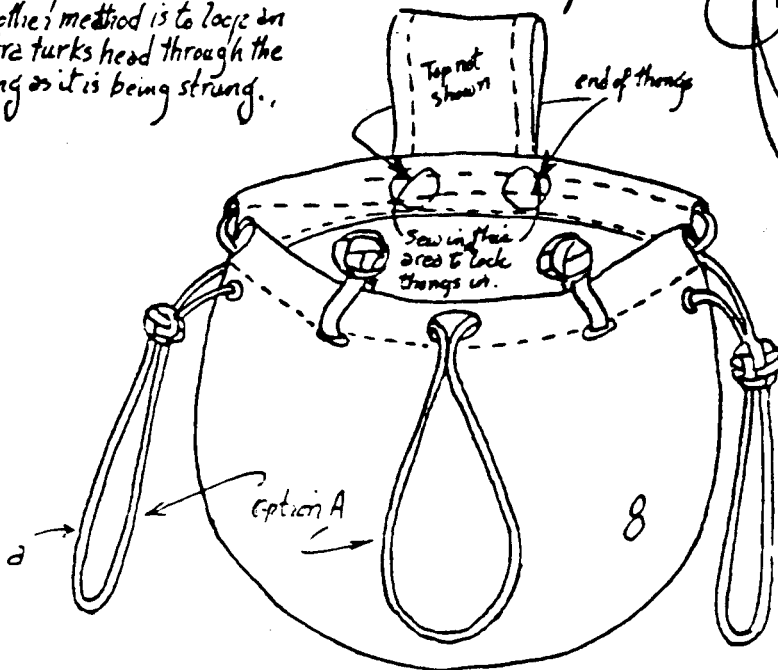
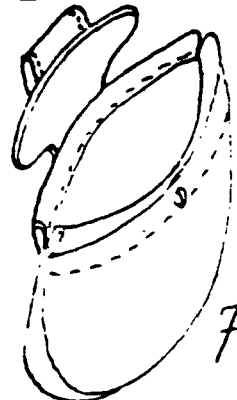
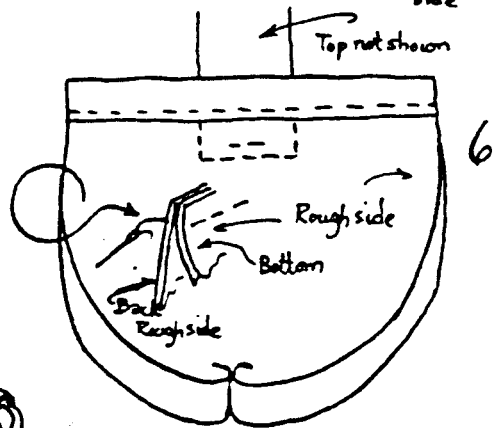
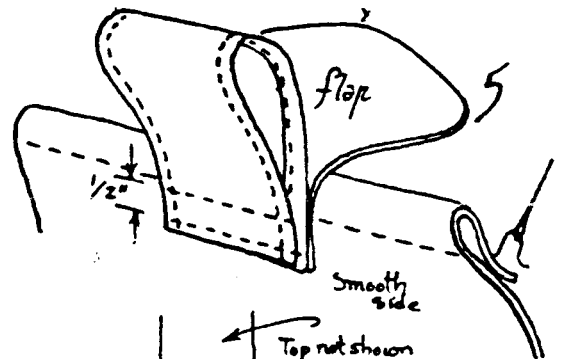
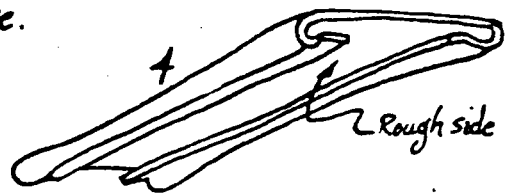
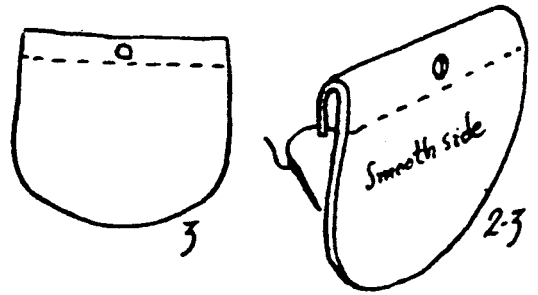
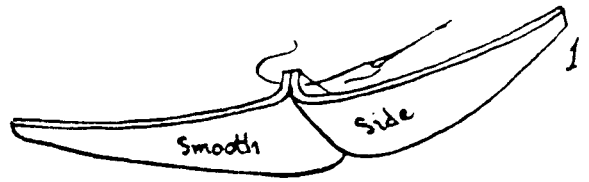

Option "A" It will help keep the turk's heads from sliding off if a button knot, p. 27 is tied in the bottom of each loop as it is strung. However it is very difficult to get the lengths even. An easier way is to make the thong out of pieces of leather and knot the ends as shown on plate 26. Another method is to loop an extra turk's head through the thong as it is being strung.

Pattern produced by Glen Colverson of the
National Museum of Antiquities, Edinburgh, Scotland

Duntomknackan
335 Vallejo St.
Petaluma, Ca.
94952

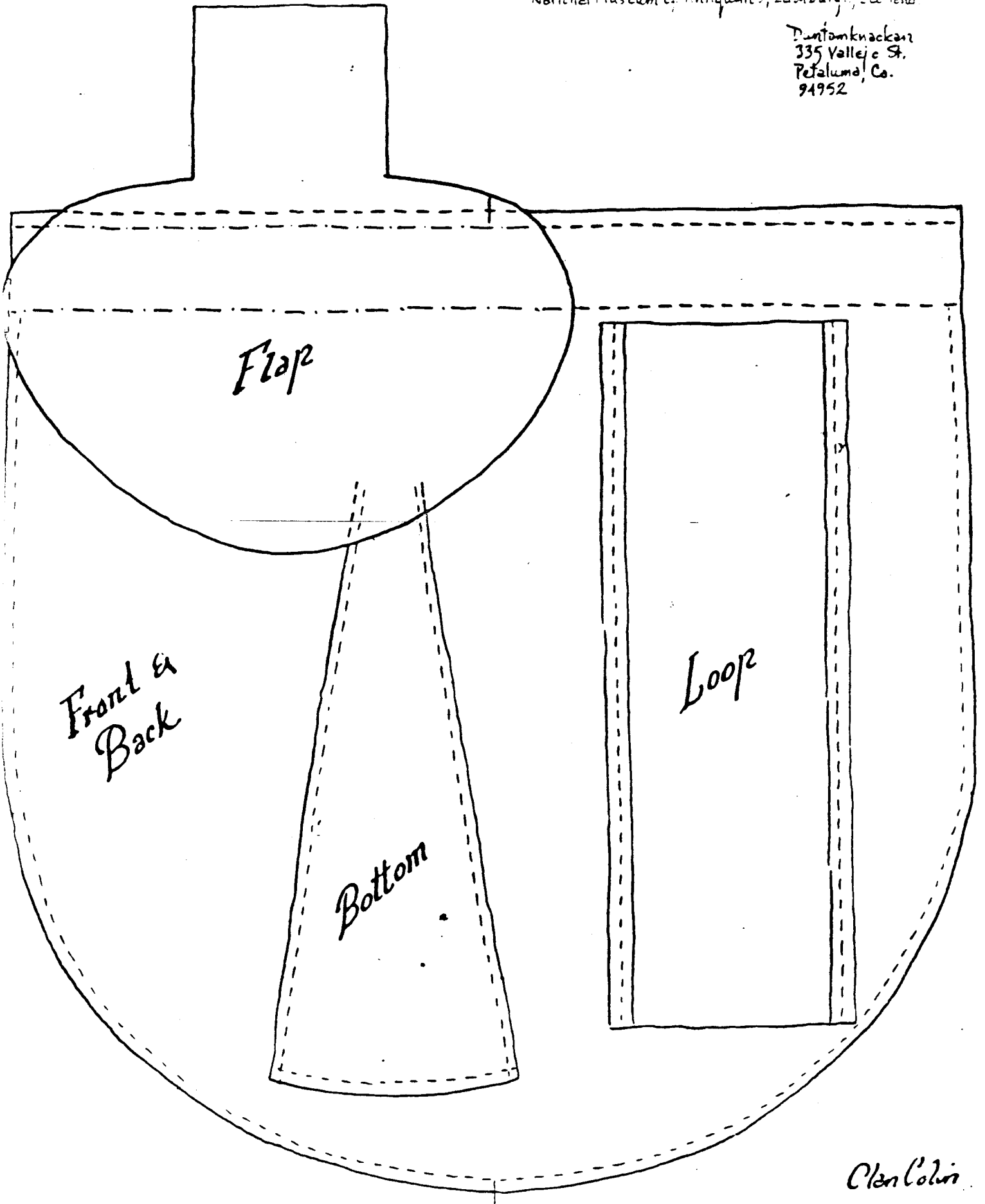

Glen Colverson

Tandy AA Large Eyelets
 Eyelets may be omitted for 18th
 Century Authenticity -

Back is front cut from FLEXIBLE
 LEATHER SUCH AS TANDY BACKSMITH
 SIDES!
 Lace with leather
 (Kato) laces or with
 extra long boot laces
 (women).

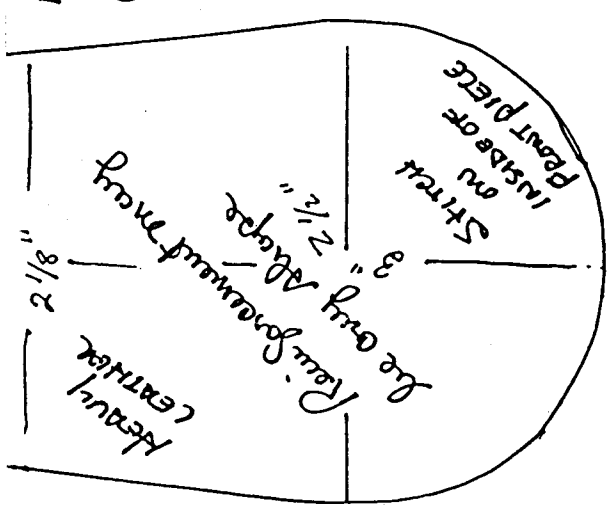

All holes in same position -
 Back & Front

Head is 2 1/2" wide by
 20" long - How much will
 crumple? How much
 back piece -
 FASTEN WITH 3/4"
 Button
 Larger button

Lower Supp. 3 eye cord
 (or regular brown
 medium brown)

8" - all rows
 11" - all rows
 Prior to sewing

Use a narrow backstitch
 awl to sew up all seams.

LIN ROBINSON
 206 CREST RD
 HENDERSON, NC 27536

Subst. right
 ST. M. 1800

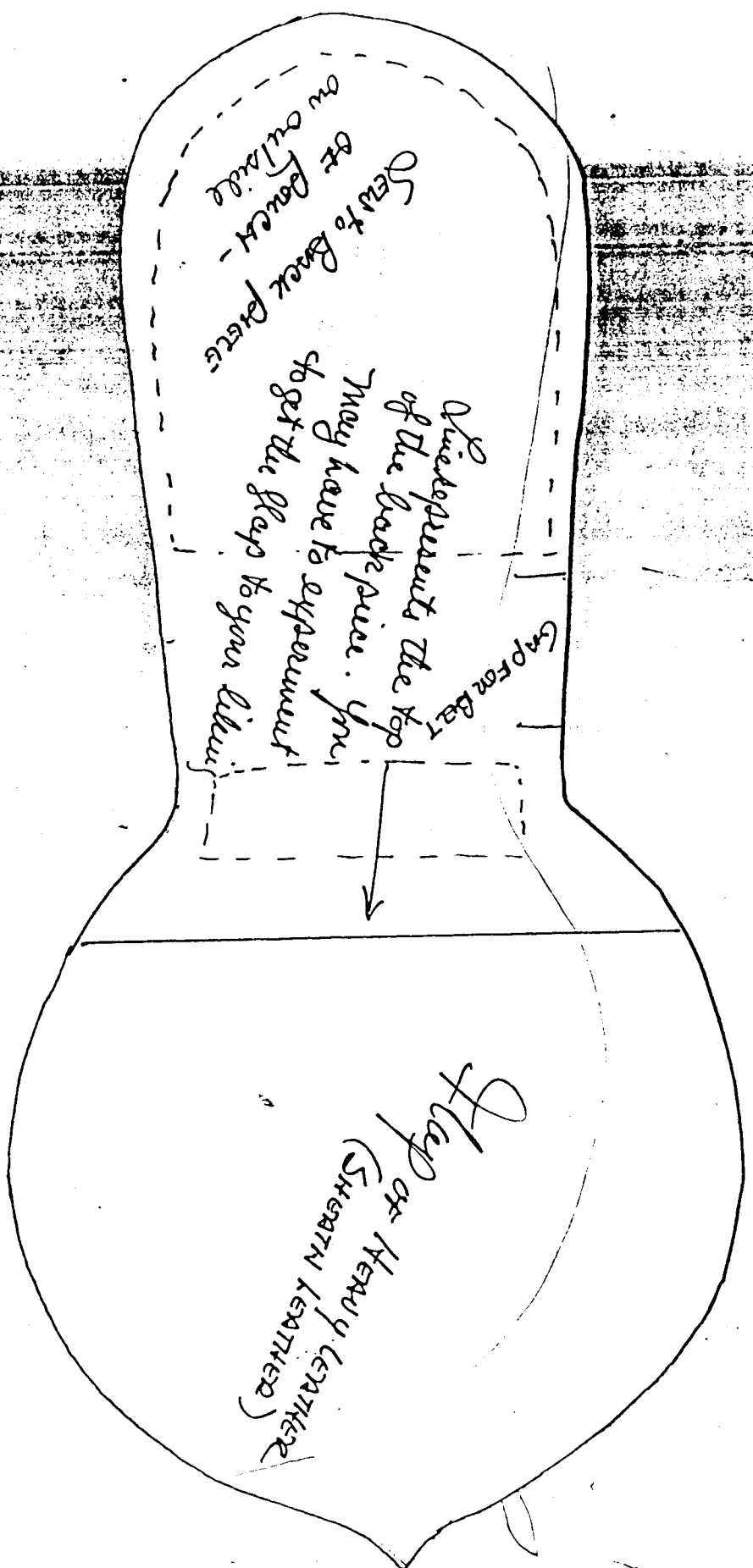

Sent to Brock Price
on outside
of Brock Price

Development's the top
of the boot price. You
may have to experiment
to get the flap to your liking

Emp Form Bar

Flap of Heavy Leather
(SHEARIN LEATHER)

It is nice to decorate the top flap. One method is to top with brown lace through rows of slots as shown below. Note Fig 8, a is dummy pull cords with same turks heads as Fig 10 but threaded through holes punched in sides of Sparrow 11.

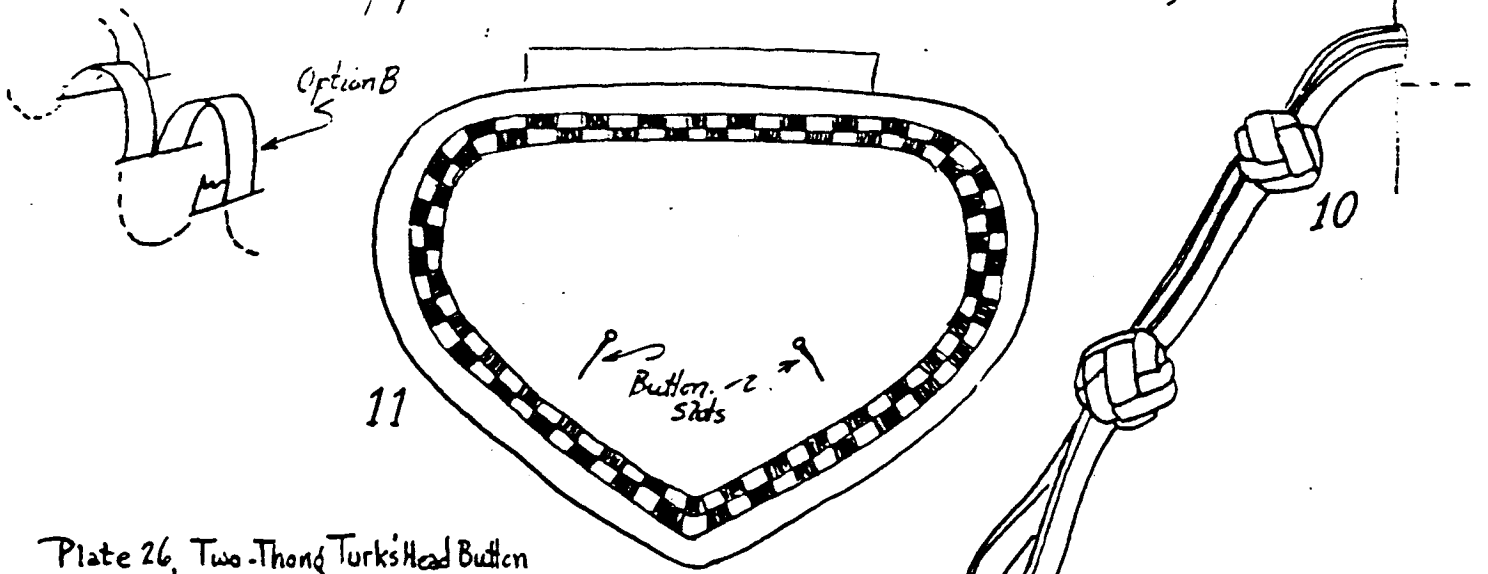

Plate 26, Two-Thong Turks' Head Button

Made with a shaft thong of $\frac{1}{8}$ " width. First step, fig 1, double thong with flesh sides together. Loop end B as shown and bring it round under A. Place A across loop formed by B. Pass B over A and through this loop. (Fig 2).

Bring A around underneath and up through its own loop as indicated by arrow line fig 3. The loose knot shown in Figs 4 & 5 is tightened by pulling easily on both ends of the thongs. Ends may be cut off flush with the knot as left.

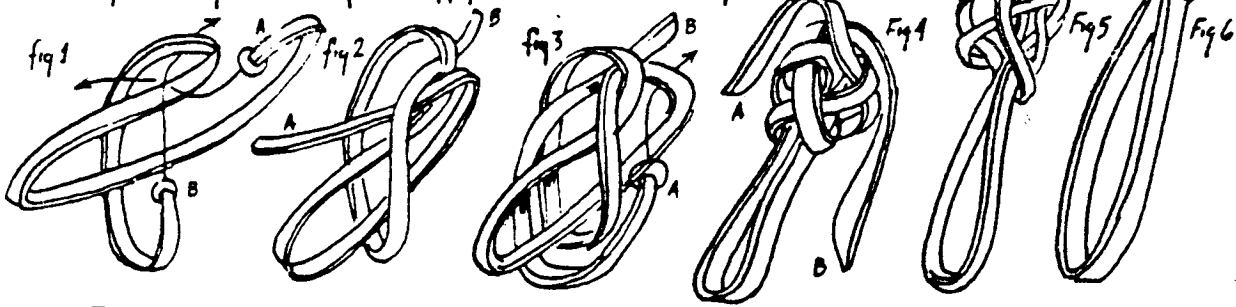

Plate 27, Button Knot -

Lay the thong over a mandrel as shown in fig 1. Twist thong B into a loop as shown in fig 2 with the bight over thong A. Bring thong A under thong B and in an over-one-under-one sequence, as indicated by the arrow-line in Fig 2. Fig 3 shows the completed bend.

Bring the end of thong B up through the centre on its own side as indicated by the arrow-line in Fig 3. Thong A follows a similar course on its own side, as shown by the arrow-line. Remove the loose knot from the mandrel, and bring the two ends together, with their flesh sides touching. Begin to tighten the knot carefully, first taking up the bight which originally was around the mandrel. The knot now appears as shown in Fig 4. Tighten it gradually, always holding the two ends together until finished, as shown in Fig 5.

